

This License allows you to build and/or print only one copy of the Paper Model from a single computer/printer.

This License does not allow the Paper Model to exist on more than one computer and you may not make the Paper Model available over a network where it could be accessed by multiple computers or multiple copies. You may not sell, rent, lease, loan, sublicense or otherwise distribute the Paper Model or modifications of the Paper Model. You may not transmit or distribute the Paper Model by any broadcast medium, whatsoever.

This Model is protected by the United States Patent and Copyright Office and is the sole property of Synergy Icons, Inc. / Paper Models, Inc.

Anyone who infringes on the intellectual property rights provided by this copyright and patent pending, shall be prosecuted to the fullest extent of the law.

## These are the Instructions

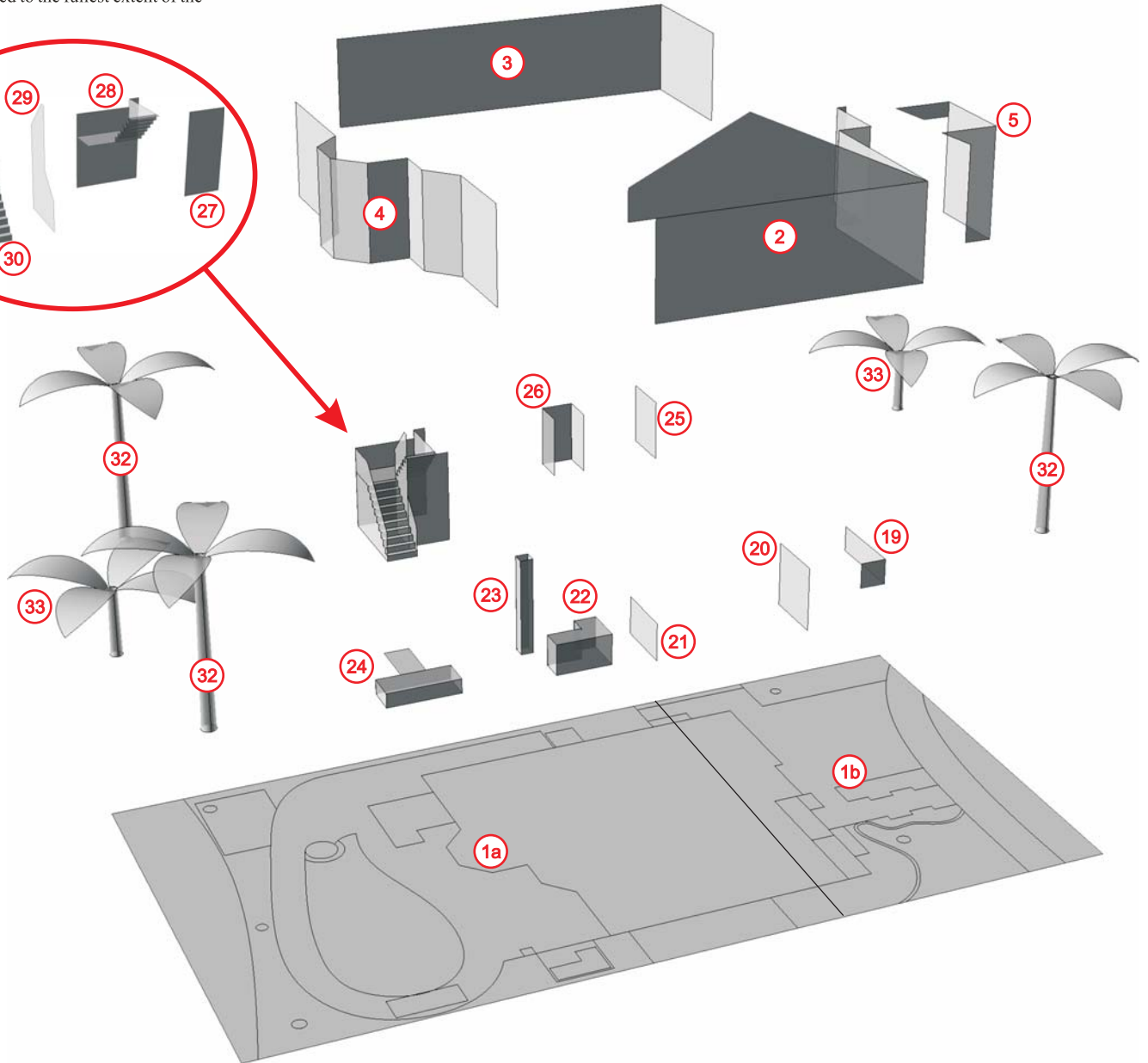
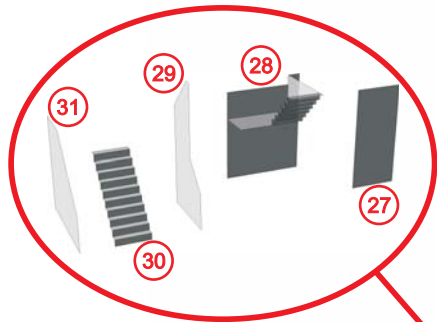
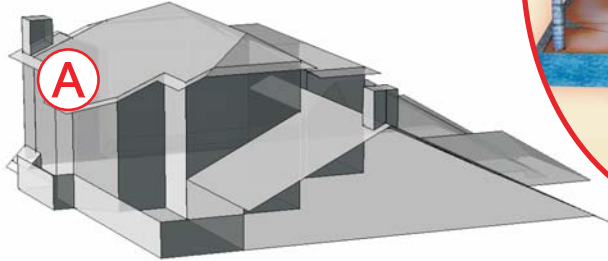

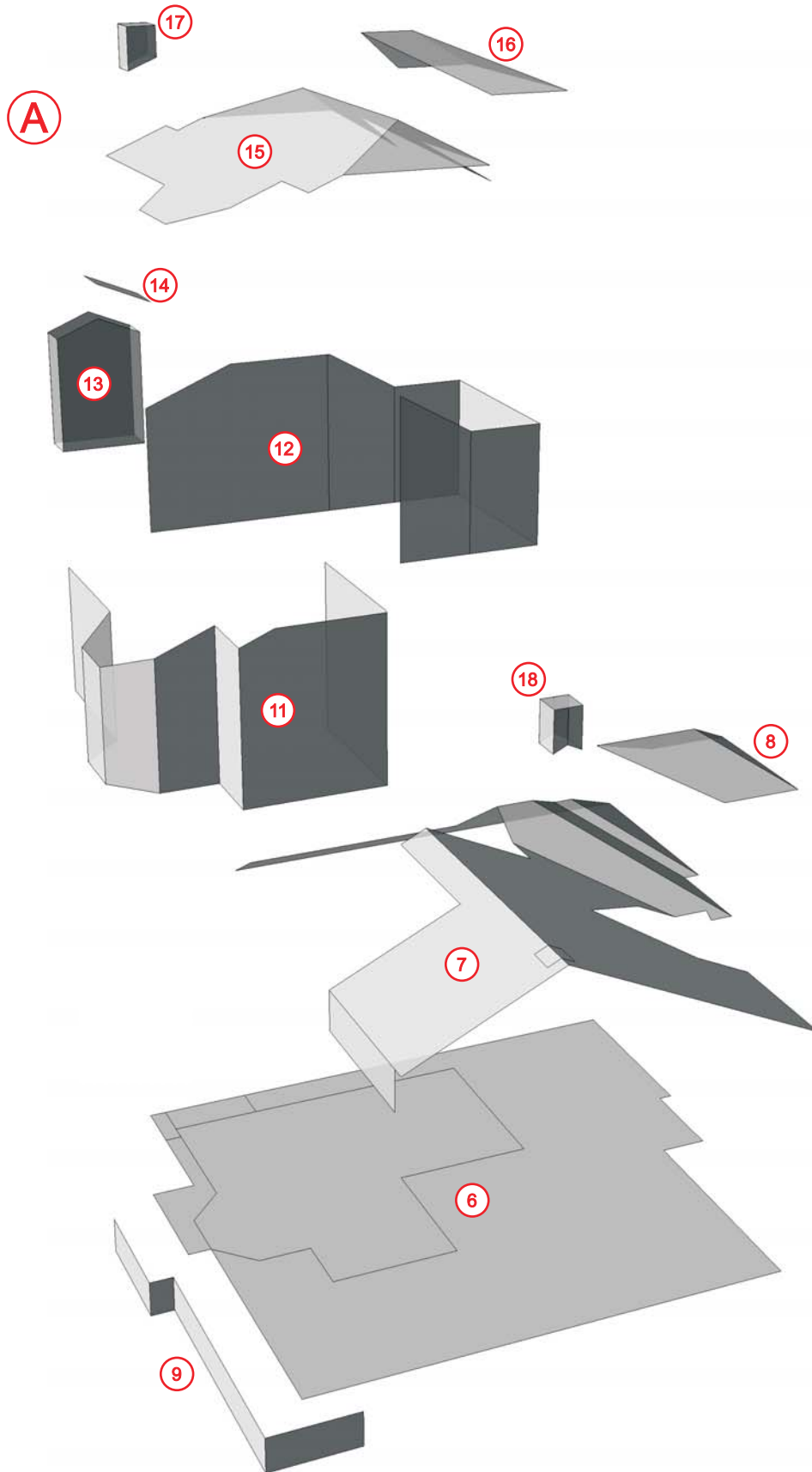

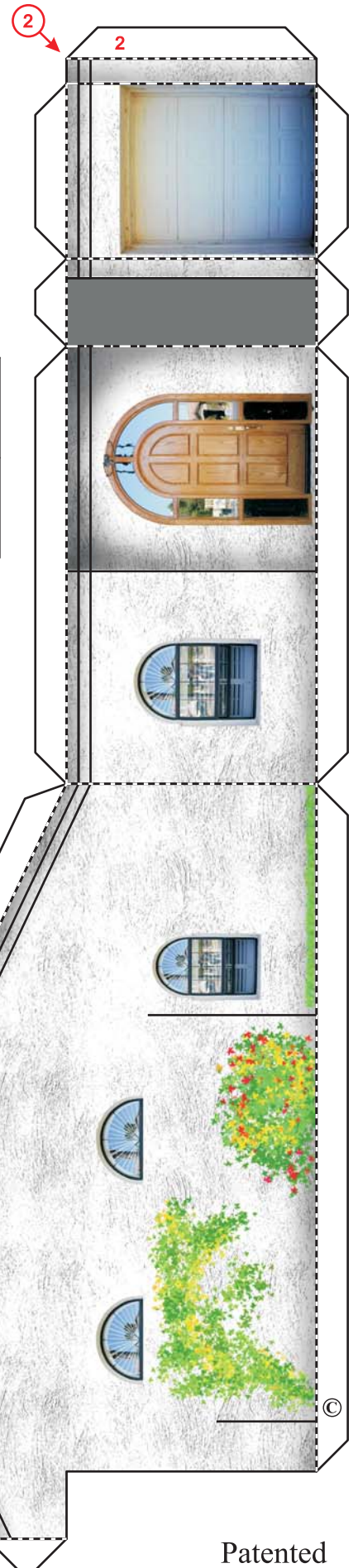
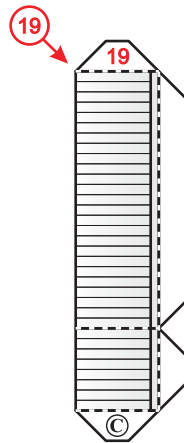
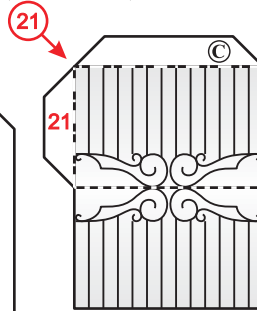
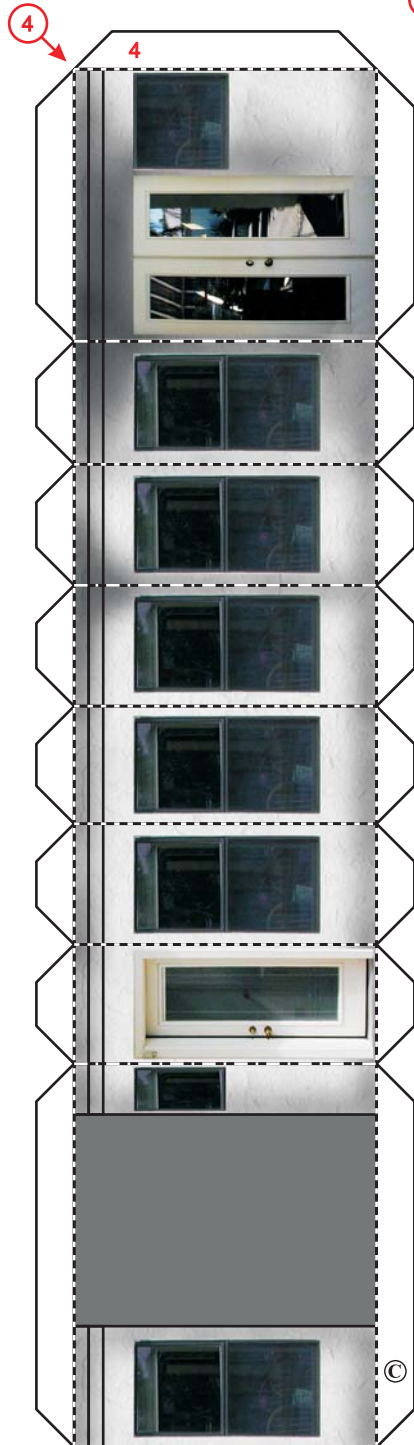
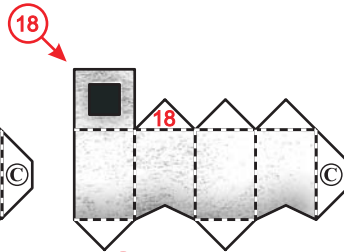
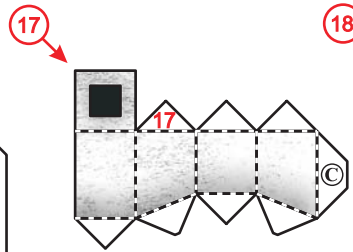
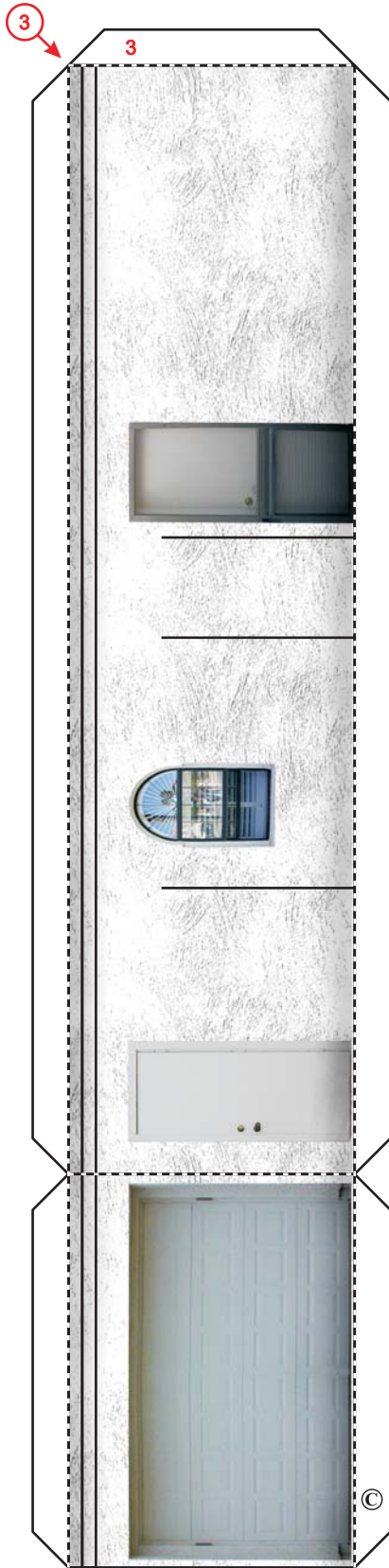

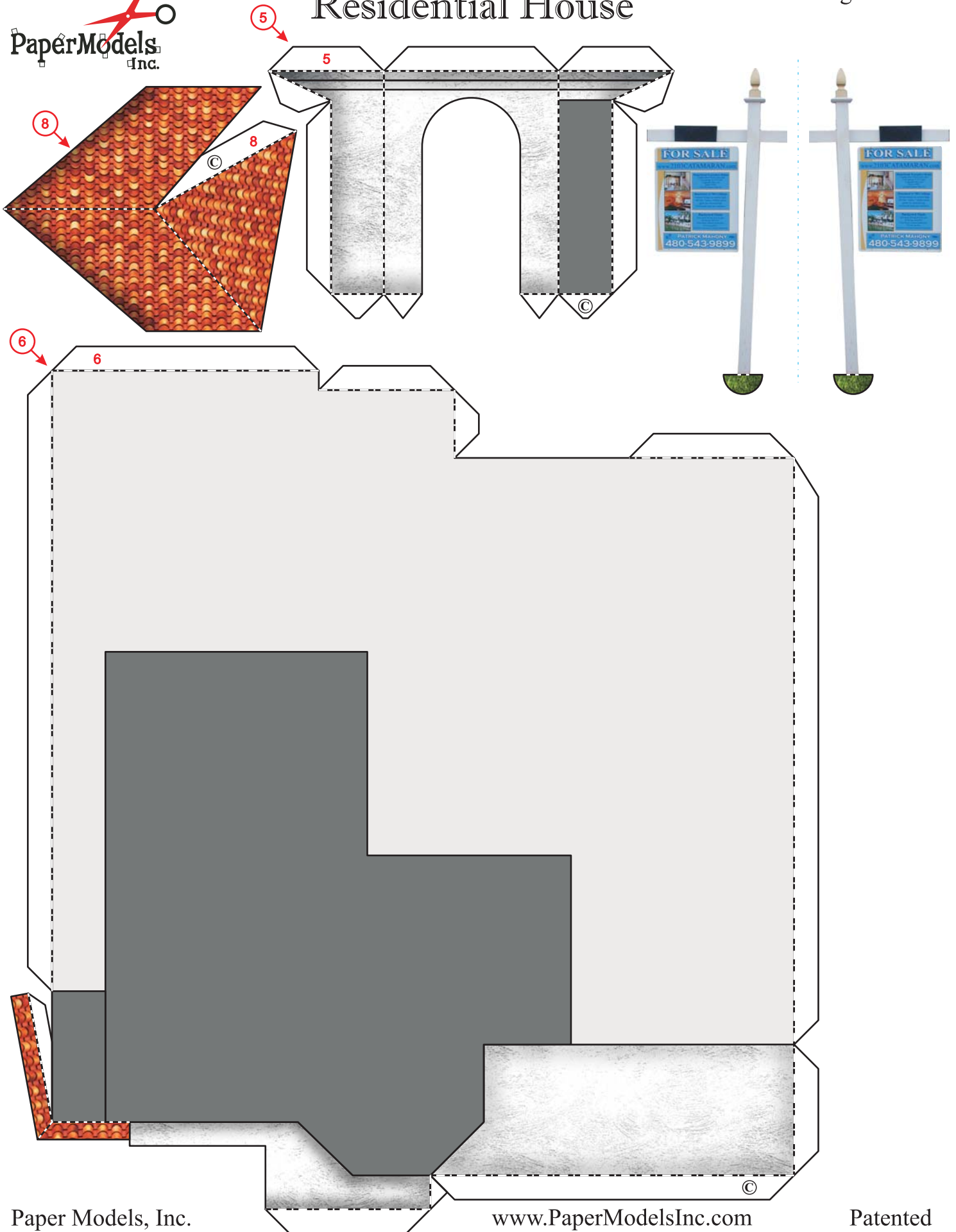

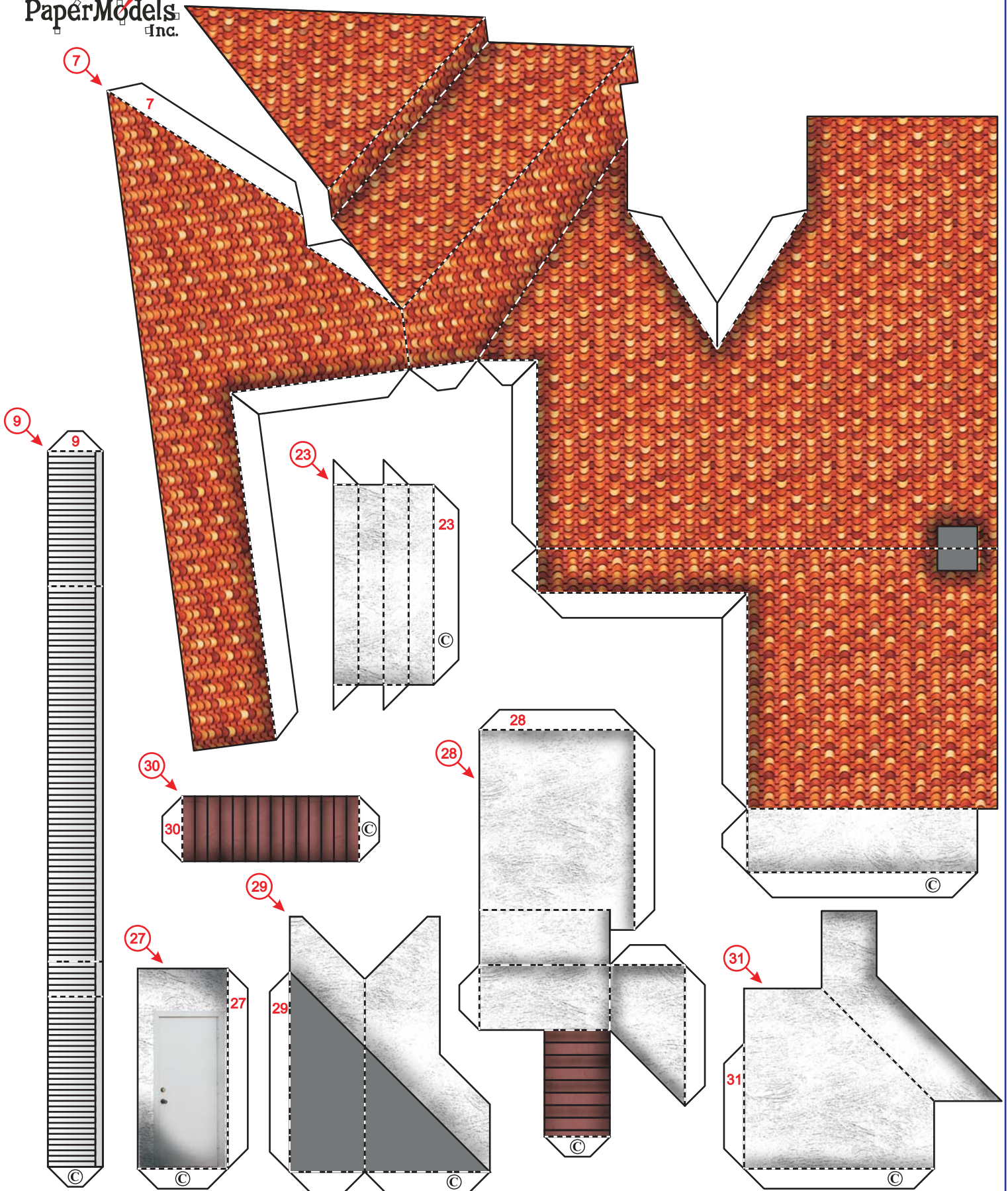

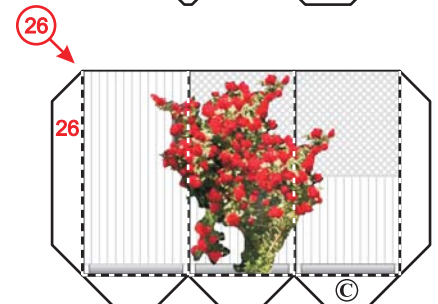
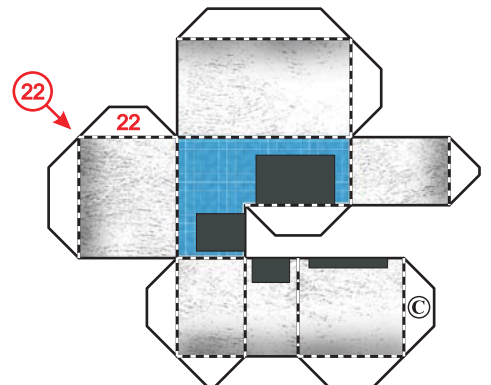
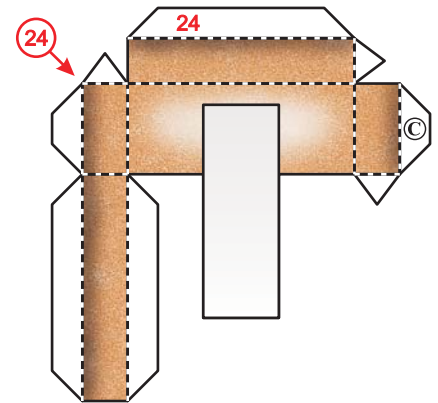
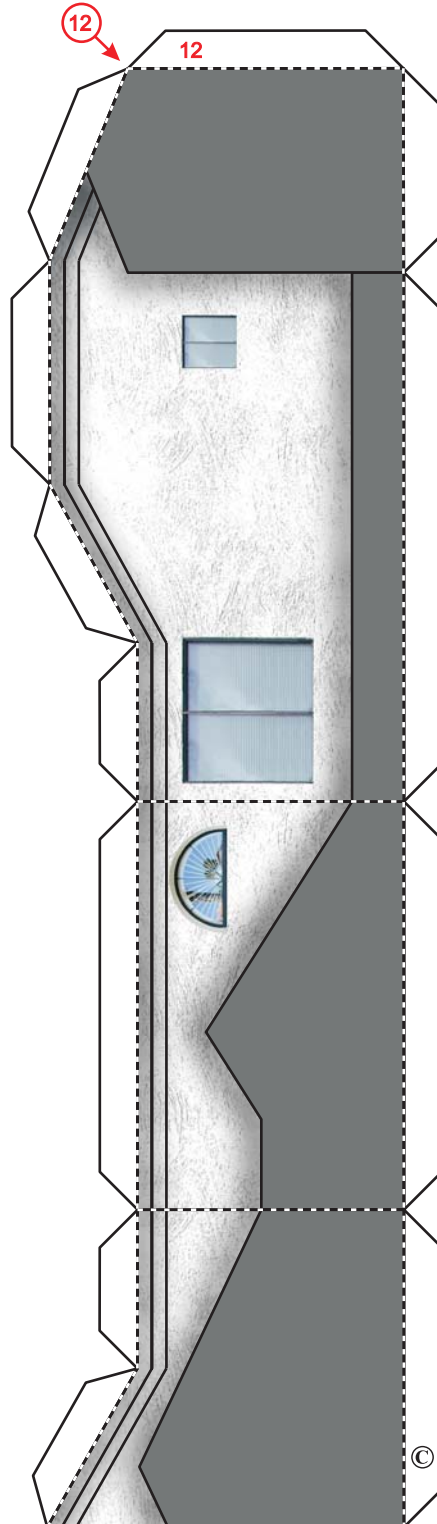
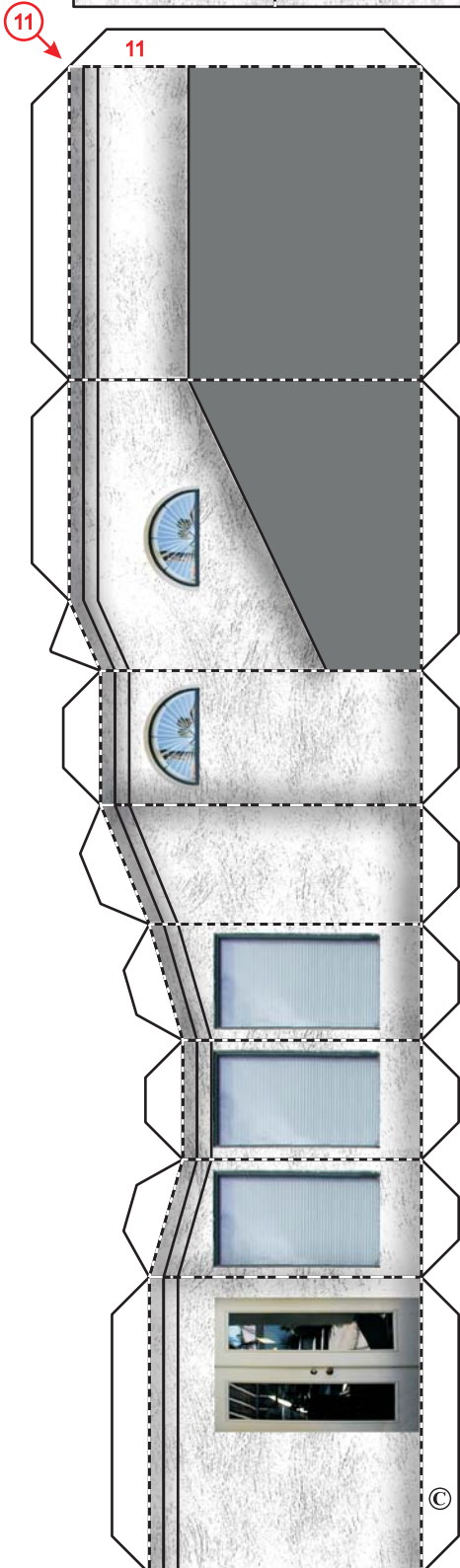
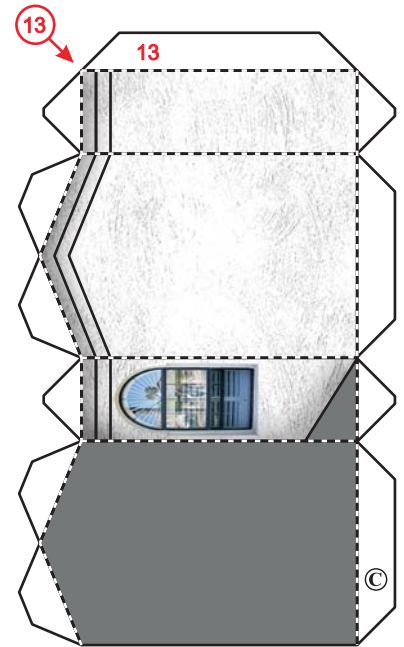
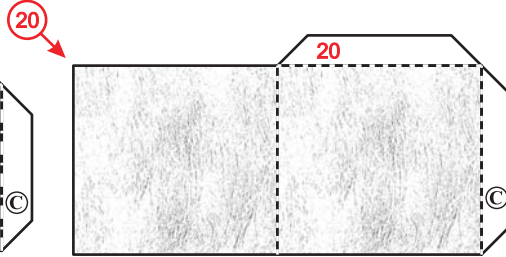
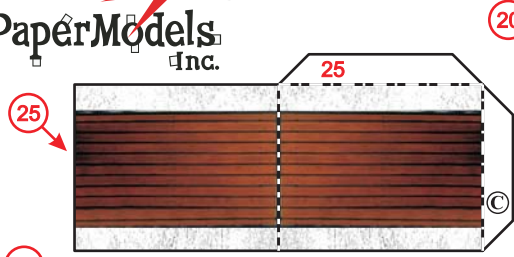

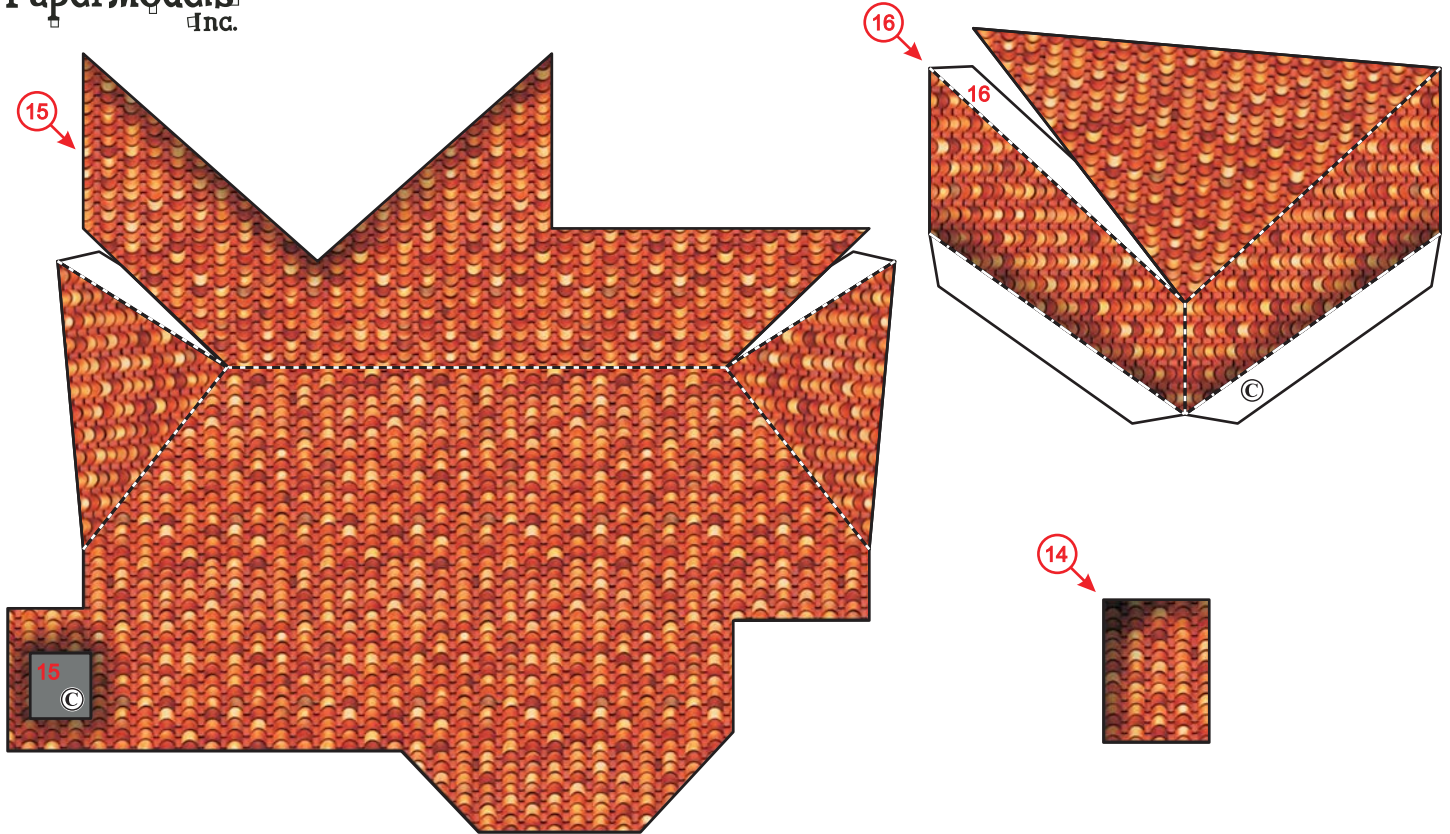

32

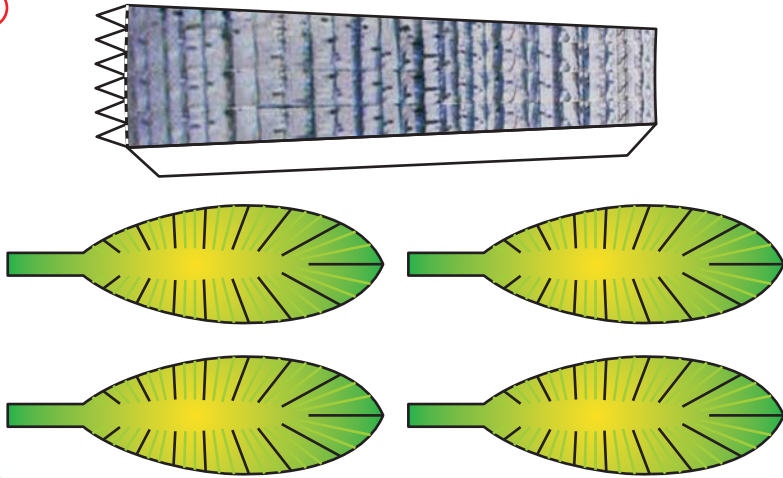

33

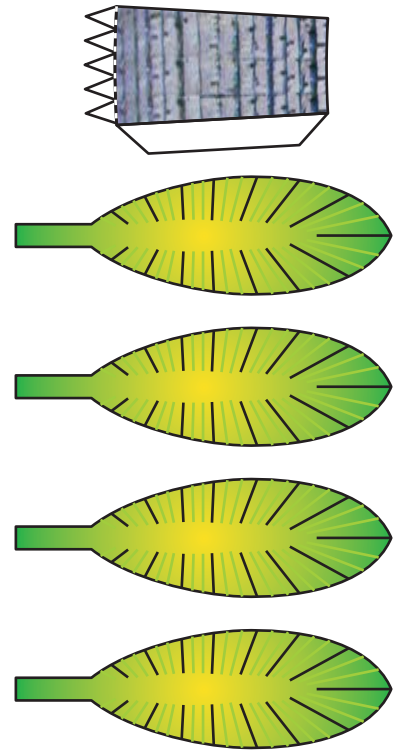

32

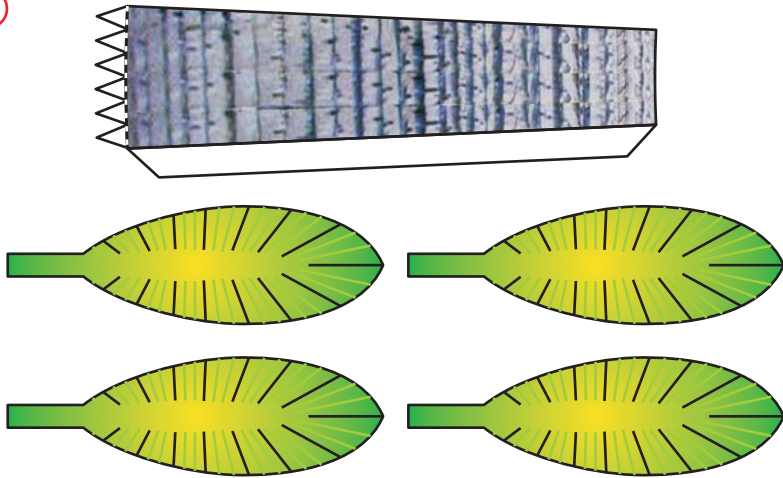

33

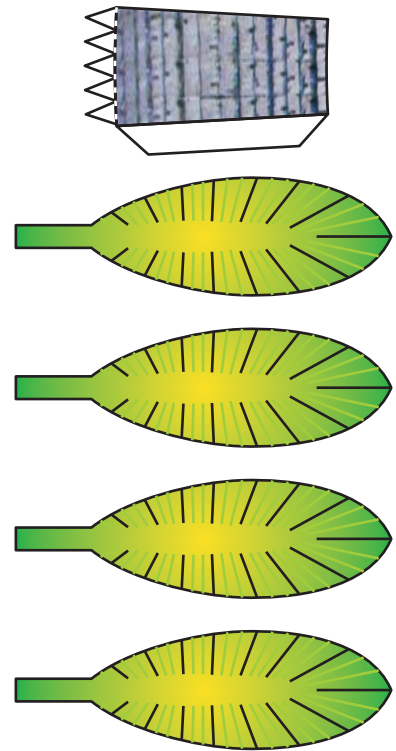

32

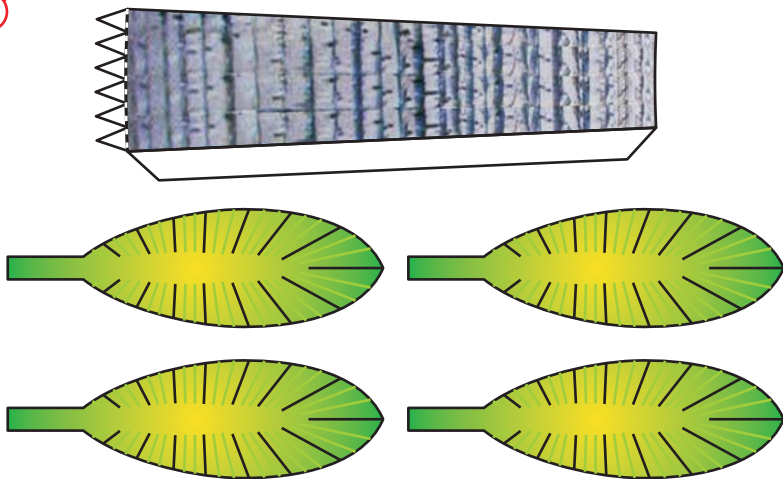

1a

# Residential House

Page 9 of 9



Paper Models, Inc.  
[www.PaperModelsInc.com](http://www.PaperModelsInc.com)

Patented

©

